

M12 MALE,0° SHIELDED, D CODED, ETHERNET

PUR 2x2xAWG22 shielded green UL,CSA+dragchain 8m

Ethernet CAT5

Male straight

M12, 4-pole

D-coded

shielded

Further cable lengths on request.

Plastic housings with good resistance against chemicals and oils.

The resistance to aggressive media should be individually tested for your application. Further details on request.

Transmission properties with channel transmission up to 100 m

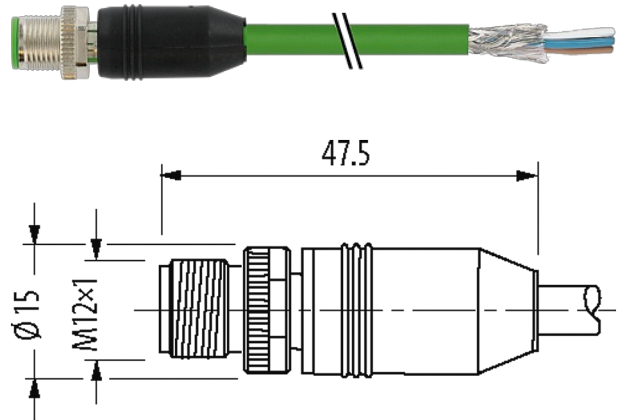
Illustration

Product may differ from Image

Approvals

* only for products with UL/CSA approved cable

cCSAus

More Info



Form

Form 14541

Cables

No./diameter of wires	2 × 2 × 0.34 mm ²
Wire isolation	PE (wh, ye, bl, or)
C-track properties	3 Mio.
Jacket Color	green
Material (jacket)	PUR (UL/CSA)
Outer Ø	6.7 mm ±5%
Bend radius (moving)	12 × outer Ø

Temperature range (fixed)	-40...+80 °C
Temperature range (mobile)	-30...+70 °C
Cable identification	796
Approval (cable)	UL (AWM-Style 20233/11602), CSA; CE
Cable weight [g/m]	69,3
Material (wire)	Cu wire, bare
Resistor (core)	max. 55 Ω/km (20 °C)
Diameter (core)	2× 2× AWG22
Material (wire isolation)	PE
Wire-Ø incl. isolation	1.4 mm ±5%
Color/numbering of wires	wh, ye, bl, or
Shield	yes min. 85%
Material (jacket)	PUR
Outer-Ø (jacket)	6.7 mm ±5%
Color (jacket)	green
thermal resistance	flammwidrig nach UL 1581 Section 1060 (FT1), Section 1061 (cable flame), Section 1080 (VW-1) / IEC 60332-1-2
Nominal voltage	300 V
Temperature range (fixed)	-40...+80 °C
Temperature range (mobile)	-30...+70 °C
Bend radius (fixed)	5× outer Ø
Bend radius (moving)	12× outer Ø
No. of bending cycles (C-track)	max. 3 Mio. (25 °C)
Traversing distance (C-track)	max. 5 m (horizontal)
Travel speed (C-track)	max. 3.3 m/s
Acceleration (C-track)	max. 2 m/s ²
Technical Data	
Operating voltage	max. 60 V DC
Operating voltage (only UL listed)	max. 30 V DC
Rated surge voltage	1.5 kV
Operating current per contact	max. 4 A
Material group	IEC 60664-1, category I
Transfer parameters	CAT5, Class D (ISO/IEC 11801:2002), (EN 50173-1)
Transfer rate	up to 100 Mbit/s full duplex
Coding	D-coded
Locking of ports	Screw thread (M12×1 mm) recommended torque 0.6 Nm, self-securing
Compression gland	M12 (SW13)
Protection	IP65, IP66K, IP67 inserted and tightened (EN 60529)
Locking material	Zinc die casting, matte nickel plated
Material	PUR
suitable for corrugated tube (internal Ø)	without
General data	
Standards	DIN EN 61076-2-101 (M12)
Pollution Degree	3
Temperature range	-25...+85 °C, depending on cable quality
Commercial data	
country of origin	DE
customs tariff number	85444290
EAN	4048879497169

eClass 27061801

Packaging unit 1

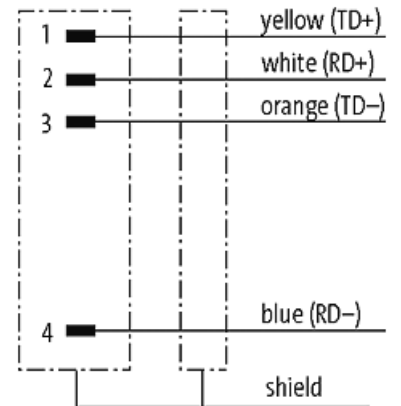
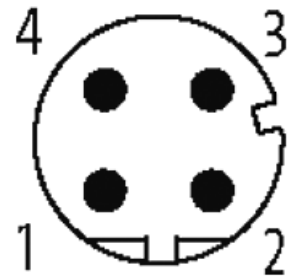
Sketch**Male**

Product may differ from Image